

K11LED3W



LED lighting KIT made up of LED module with flex stem and stabilized current LED driver.

- High efficiency LED technology – free maintenance
- 5000 K light color
- **Adjustable light beam width**
- 230 VAC power supply with external LED driver

DIMENSIONS

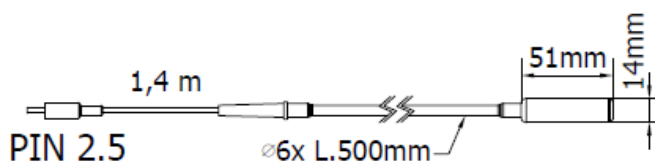
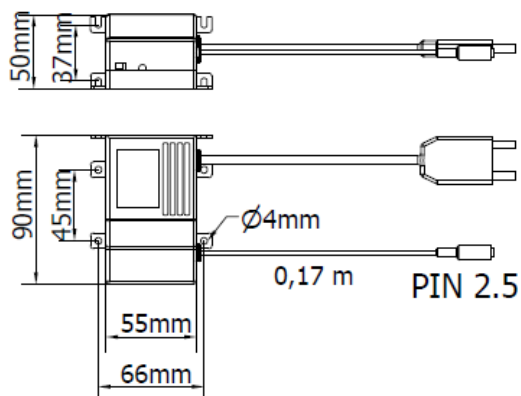

A11LED3W FEATURES (DRIVER)

Power usage	3 W
Power supply	230 Vac
Light source	-
Electrical connection	Europlug + 2.5 mm DC power socket
Housing	ABS
Protection index	IP40
Front protection	-
Operating temperature	-20°C to +45°C (-04°F to +113°F)
Weight	0,40 kg (0,82 lb)
Agency approval	CE, RoHS
Mounting	Screws

L11LED3W FEATURES (LED)

Power usage	3 W
Power supply	3.8 Vdc
Light source	LED
Electrical connection	2.5 mm DC power plug
Housing	Aluminum and ABS
Protection index	IP40
Front protection	Polycarbonate
Operating temperature	-20°C to +45°C (-04°F to +113°F)
Weight	0,1 kg (0,22 lb)
Agency approval	CE, RoHS
Mounting	Clip

230 VAC ELECTRICAL CONNECTION WITH LED DRIVER

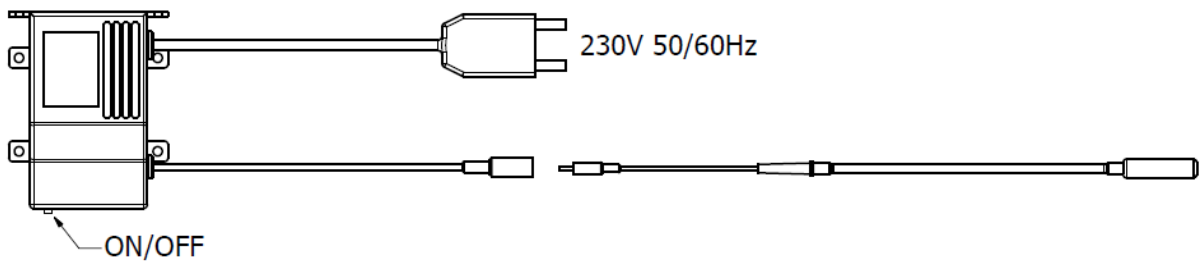

OPTICAL FEATURES

Model	N° and type of LED	LED Lifespan	Light color	CRI	Light Beam Angle	Luminous flux	Efficiency
L11LED3W	1 Power LED	60 000 h L70 **	5000 K	80	Adjustable	~ 75 lm	~ 25 lm/W

** Flow beam reduced by less than 30% after 60,000 hours

PHOTOMETRIC DIAGRAMS (narrow beam)

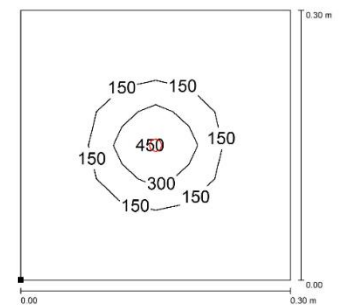
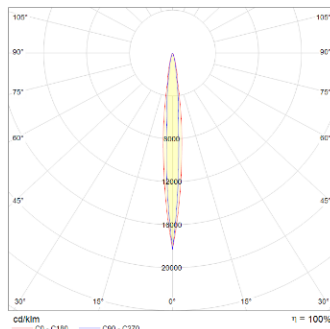

Distance graphic: 0,3 m

PHOTOMETRIC DIAGRAMS (wide beam)

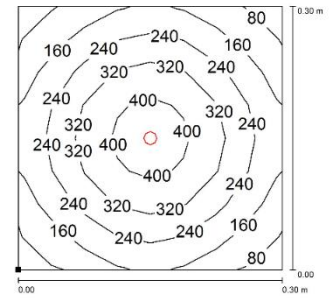
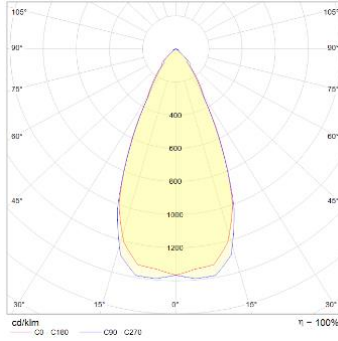
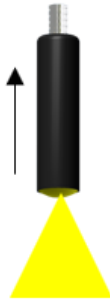

Distance graphic: 0,3 m

ORDER CODES

Model	Description
L11LED3W	FLEX 1 LED 5000K 3W
A11LED3W	LED driver, 3W, 230V, Cable 6.5ft.(2m) europlug
K11LED3W	KIT FLEX 3W 230VAC 1,5m